

Stahl-Umfassungszarge Typ TTUD auf MBW oder LBW, aus 1.5 mm elektrolytisch verzinktem Stahlblech, Ecken auf Gehrung.

Kombinierbar mit Türen von 39-46mm Dicke:	
DB/40(.A)	Schallhemmend, o./m. Alu, 40mm
DB/45(.A)	Schallhemmend, o./m. Alu, 45mm
GL/10.VSG	Glastür, Verbund-Si.-Glas, 10mm
GL/8.ESG	Glastür, Einscheiben-Si.-Glas, 8mm
HGL/40	Holz/Glastür, 40mm
RS/40(.A)	Röhren-Vollspan, o./m. Alu, 40mm
RS/45(.A)	Röhren-Vollspan, o./m. Alu, 45mm
VS/40(.A)	Vollspan, ohne/mit Alu, 40mm
VS/45(.A)	Vollspan, ohne/mit Alu, 45mm
WD/45.A	Wärmed., mit Alu, 45mm, Ud 1.1

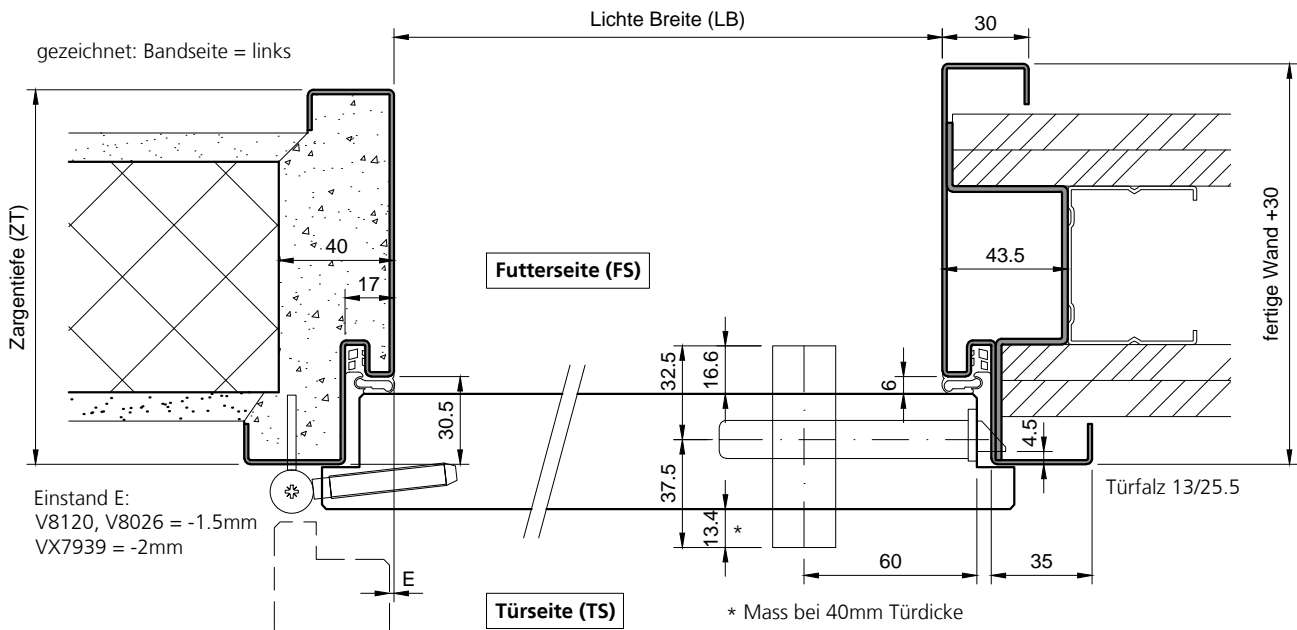

Typ: S
(Schwellenwinkel)

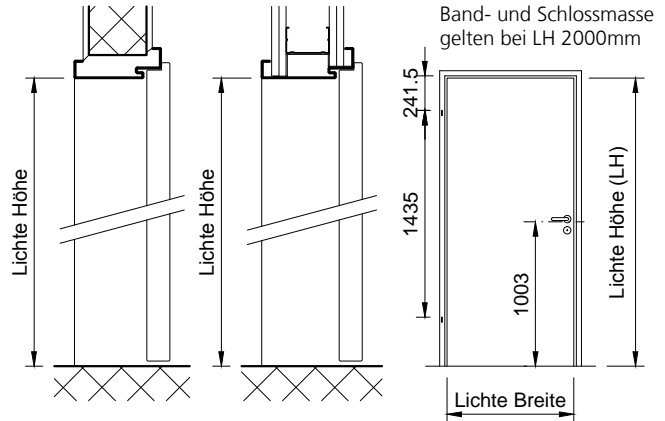
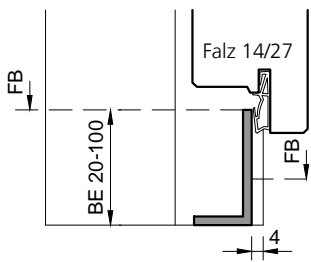

Typ: S
(Schwellenwinkel)

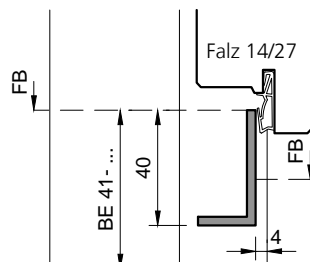

Typ: S+S
(Doppelschwelle)

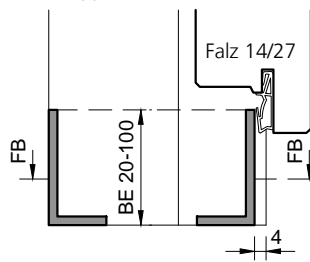

Typ: S+S
(Doppelschwelle)

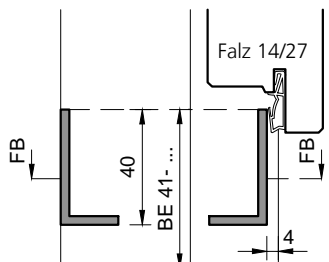

Typ: S (auf FS)
(Konterschwelle)

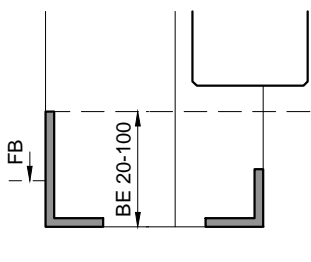

Typ: S (auf FS)
(Konterschwelle)

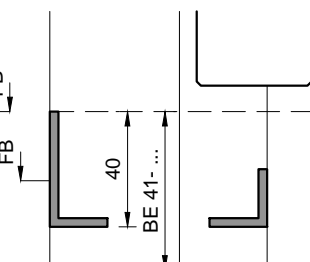

Typ: V
(Verbindungsisen)

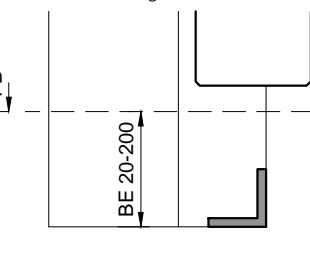

Typ VP
(prov. Verbindungsisen)

